

PNS153F INSTALLATION INSTRUCTIONS

© Panduit Corp. 2002

Printed in Singapore

CABLE REQUIREMENT: Terminates most 22-26 AWG solid or stranded IWC wire with a .050" (1.27mm) max. o.d., either PVC or Plenum rated.

LOCATION

Mounting a system at the right height will make wiring changes and additions cost efficient. The optimum height, from the floor to the top of a 72 port/432 pair *GIGA-PUNCH™* base, is 68 inches. If the customer needs don't exceed the wiring capacity of one base of 24 port/144 pair, the optimum distance from the floor to the top of the system can be reduced to 43 inches. This height will allow for expansion of 72 port/144 pair on top and 72 port/432 pair underneath.

WALL MOUNT BASES WITH LEGS

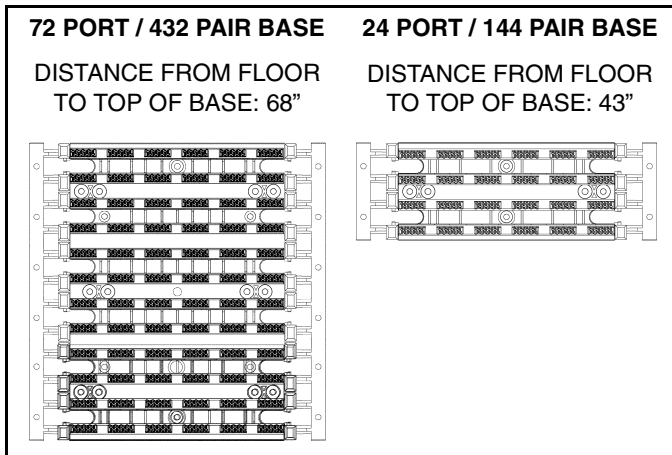

19" RACK MOUNT PANELS

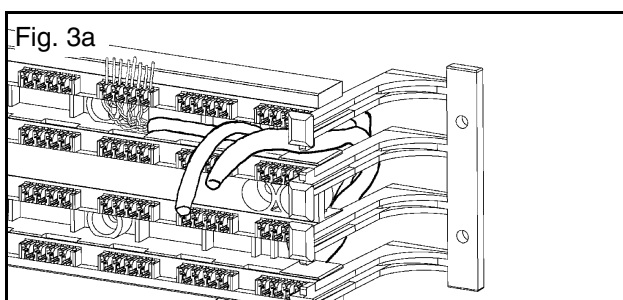
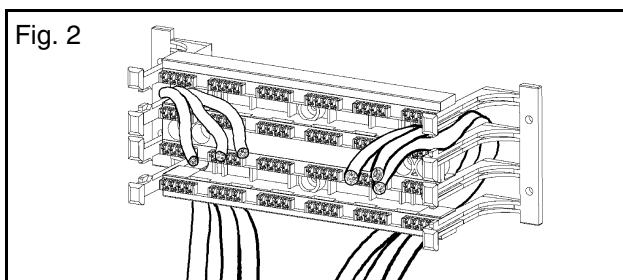
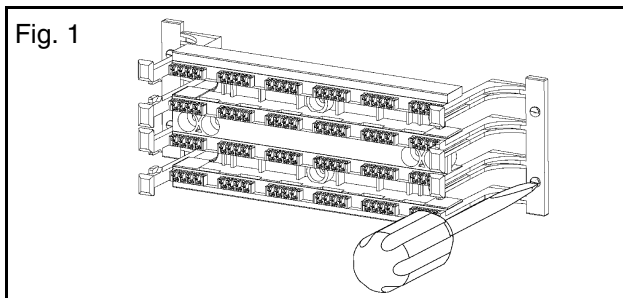
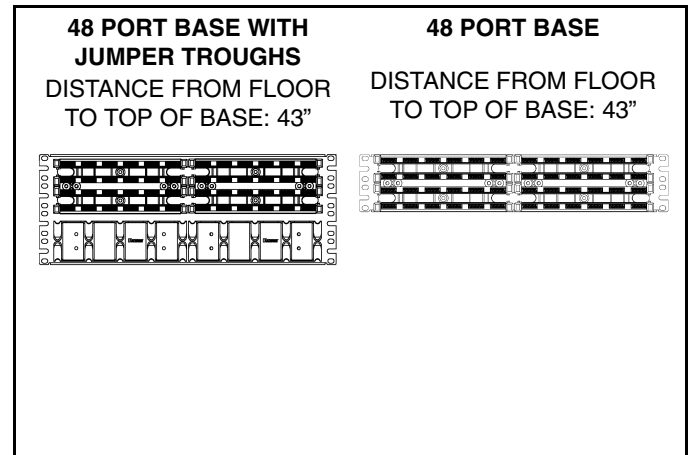

INSTALLATION

1. Use appropriate mounting hardware to install base on desired surface as shown in Fig. 1, 3/4" plywood is recommended. (Tip: *PANDUIT* lettering should be upright.)
2. Route cables through the slots in the base as shown in Fig. 2.
3. Cable jacket end should be within 1/2" from where cable pairs are inserted. Cable pairs must remain twisted up to the point of connection for Category 6 installation.

Note: When using 4-pair cable, high density bases must be wired from the center out to each side, as shown in Fig. 3a.

CATEGORY 6 DATA WIRING SCHEME

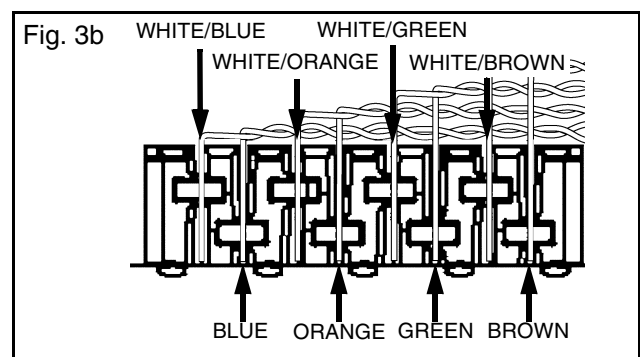

PNS153F INSTALLATION INSTRUCTIONS

CABLE REQUIREMENT: Terminates most 22-26 AWG solid or stranded IWC wire with a .050" (1.27mm) max. o.d., either PVC or Plenum rated.

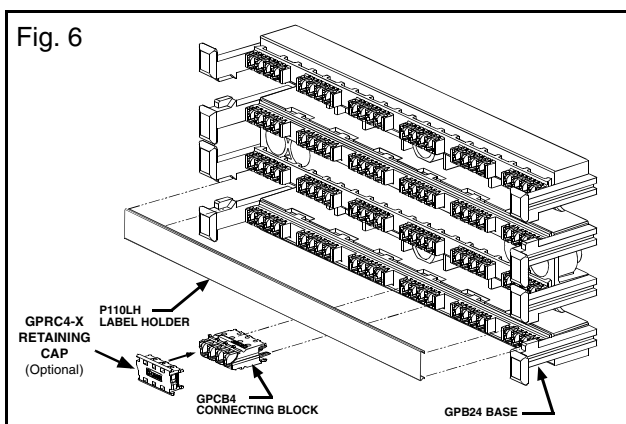
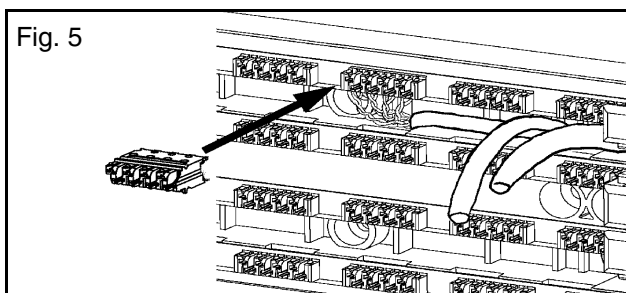
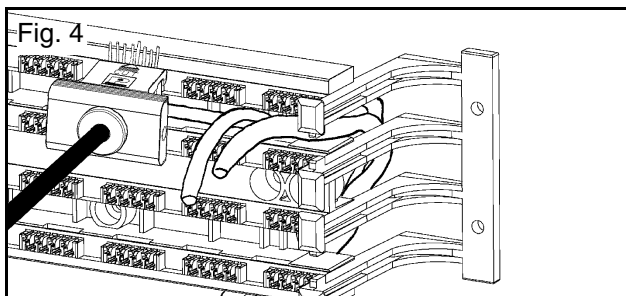

4. Inspect cable pair color placement prior to using either a GPST single wire punchdown tool or GPDTM multi-pair punchdown tool to seat and cut the pairs to length.

Note: When using a single wire punchdown tool to insert and cut wires, the HIGH impact setting should be used.

5. Position the connecting block over the wired base.
6. Secure the connecting block in place using the GPDTM multi-pair punchdown tool. It is important to keep the tool perpendicular to the base to ensure a good termination.
7. Once the connecting blocks have been seated, cross-connect wires can be terminated to the top of the connecting blocks or *GIGA-PUNCH™* patch cords can be installed. If cross-connecting, reference Fig. 3b.

Note: Optional retaining cap can be installed at this time.

8. Add cable identification to the label, fold label, and slide it into the label holder. The label and label holder snap into position on the base in-between rows of connecting blocks as shown in Fig. 6.

Pair	Tip Color	Ring Color
1	White/Blue	Blue
2	White/Orange	Orange
3	White/Green	Green
4	White/Brown	Brown

INSTALLATION TIPS:

1. *GIGA-PUNCH™* product terminates most 22-26 AWG solid or stranded IWC wire with a .050" (1.27mm) max. o.d., either PVC or Plenum rated.
2. Never install wire into a slot previously used for a larger gauge.
3. Be careful to strip back cable jacket only as required for termination.
4. Use care to maintain pair twists up to the termination strip.
5. When stripping cable jacket, be careful not to cut the insulation on the individual wires.
6. Avoid sharp bends when routing cable.

As with all Wiring Accessories, the following statements apply:

1. Never install communications wiring during a lightning storm.
2. Never install communications wiring in wet locations unless the product is specifically designed for use in wet locations.
3. Never touch uninsulated communications wiring or terminals unless the communication line has been disconnected at the network interface.
4. Use caution when installing or modifying communication wiring.